

# DATASHEET

## AUTOMOTIVE ACCESSORIES

## CABLES

s.m.s, smart microwave sensors GmbH  
In den Waashainen 1  
38108 Braunschweig  
Germany

Phone: +49 531 39023-0  
Fax: +49 531 39023-599  
[info@smartmicro.de](mailto:info@smartmicro.de)  
[www.smartmicro.com](http://www.smartmicro.com)

## CONTENT

1	User Safety Warning .....	3
2	Product Specification .....	4
2.1	Plug & Play Cables.....	4
2.1.1	Plug & Play Cable for DRVEGRD 171 and DRVEGRD 152 .....	5
2.1.2	Plug & Play Cable for DRVEGRD 169 and UMRR-96 Type 153 .....	9
2.1.3	Plug & Play Cable for UMRR-11 Type 132 Automotive.....	12
2.2	Cable Stumps .....	15
2.2.1	Cable stump for DRVEGRD 171 and DRVEGRD 152 .....	16
2.2.2	Cable stump for DRVEGRD 169 and UMRR-96 Type 153.....	17
2.2.3	Cable stump Cable for UMRR-11 Type 132 Automotive.....	18
3	Legal Disclaimer Notice.....	19

## 1 USER SAFETY WARNING

Please read the entire document carefully before using the device.

### INSTALLATION

Please pay attention to the details below before installing and connecting the device:

- Only use provided or approved equipment for the operation.
- Only skilled and instructed persons shall install and connect the device.
- All connectors are pin-coded and fit in only one position.
- Be cautious when using the device on or around active roadways and pay attention to moving traffic.
- Make sure that test procedures are in accordance with local safety policies and procedures as well as company practices.

### OPERATION

Do not operate the cable or any device which is damaged.



Do not dispose electrical and electronic equipment in household trash.

### TECHNICAL SERVICE

Only use provided or approved equipment for operation.

Do not attempt to service or repair this device:

- No user-maintainable parts are contained in the device.
- To avoid electrical shock, do not remove or open the cover.
- Unauthorized opening will void all warranties.
- smartmicro is not liable for any damages or harms caused by unauthorized attempts to open or repair the device.

## 2 PRODUCT SPECIFICATION

There are Plug & Play Cables available for every sensor model. See 2.1.

There are also cable stumps available for every sensor model. See 2.2.

### 2.1 PLUG & PLAY CABLES

Plug & Play Cables allow for easily connecting a smartmicro sensor.

The following types are available:

Cable Type	Sensor Compatibility	Connecting To
Plug & Play Cable for DRVEGRD 171 and DRVEGRD 152 <sup>1</sup>	DRVEGRD 171 DRVEGRD 152	2x CAN, Sensor Power, BroadR Reach, Media Converter Power Supply; Sensor Connector
Plug & Play Cable for DRVEGRD 169 and UMRR-96 Type 153 <sup>2</sup>	DRVEGRD 169 UMRR-96 Type 153	2x CAN, Sensor Power, BroadR Reach, Media Converter Power Supply; Sensor Connector
Plug & Play Cable for UMRR-11 <sup>3</sup>	UMRR-11 Type 132 Automotive	Power Supply, RS485 (half or full duplex), Ethernet, CAN, Sensor Connector

*Table 1 – Overview of all Plug & Play automotive cables manufactured by smartmicro*

<sup>1</sup> Previously referred to as CABLE-FF002D

<sup>2</sup> Previously referred to as CABLE-FF0035 and successor of CABLE-FF0025

<sup>3</sup> Previously referred to as CABLE-0C0200

### 2.1.1 PLUG & PLAY CABLE FOR DRVEGRD 171 AND DRVEGRD 152

The Plug & Play Cable for DRVEGRD 171 and DRVEGRD 152 (previously referred to as CABLE- FF002D) is compatible with the smartmicro automotive sensor DRVEGRD 171 and DRVEGRD 152.

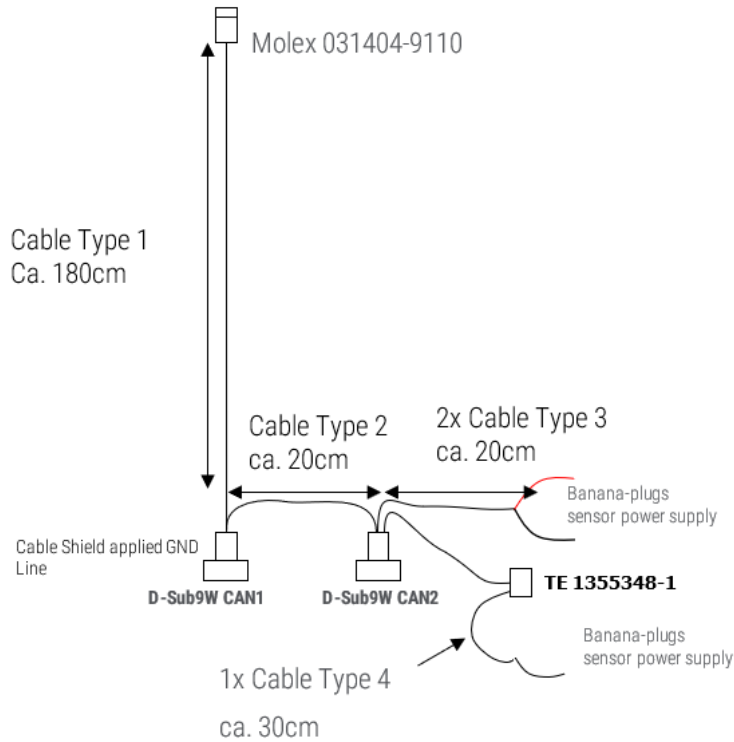
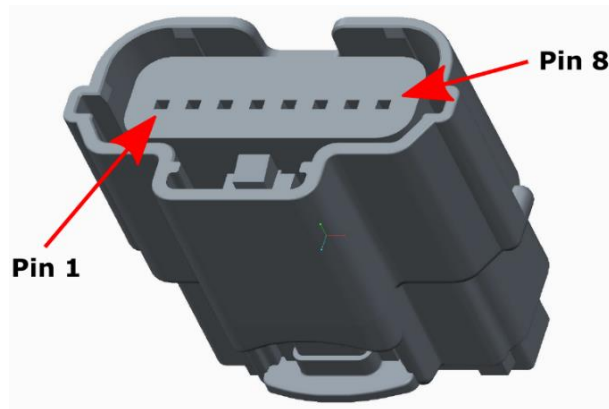
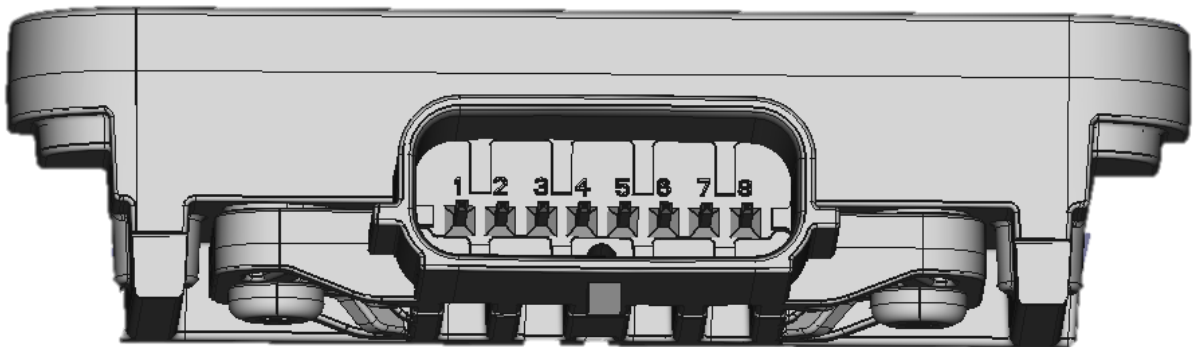

Figure 1 - Schematic Description with Cable Length

Parameter	Typical Values
Length	180cm or 5.9ft (for details see illustration)
Connectors	Sensor Connector: Molex 031404-9110 CAN1: D-Sub 9 female CAN2: D-Sub 9 female Automotive Ethernet BroadR TE 1355348-1 Power (for Sensor) + Power (for TE 1355348-1)
Cable Type	Main: 4-pair Twisted Pair, copper strands, Common shield Power: 2 x 2 strands; oval; grey (Power for Sensor and TE 1355348-1) Network: Network Cable (BroadR, CAN1, CAN2)



*Figure 2 - Cable Connector Molex 031404-9110 Pin-Out*



*Figure 3 - Sensor Connector Pin-Out*

**Please note:** Numbering 1...8 in Schematic/Figure 3 and Figure 2 are in different order. When connected, Pin 1 in Figure 4 is on Pin 8 in Figure 3



*Figure 4 - Product image; cable, including connectors*

Molex 031404- 9110	Pair	Label	DSUB-9-f CAN1	DSUB-9-f CAN2	Banana plugs Sensor power	TE 1355348-1	Banana plugs TE 1355348-1
PIN 2	1	GND	3	3	Black	10	Black
PIN 4	2	BroadR_P				9	
PIN 6	3	CAN2_H		7			
PIN 5	3	CAN2_L		2			
PIN 1	1	V+ (Sensor)			Red		
PIN 3	2	BroadR_N				8	
PIN 8	4	CAN1_H	7				
PIN 7	4	CAN1_L	2				
SHIELD		SHIELD	3				
		V+				1	Red
		(TE 1355348-1)					

**Please note:** Pin-Out between system connector and cable connector is back-to-front.

### 2.1.2 PLUG & PLAY CABLE FOR DRVEGRD 169 AND UMRR-96 TYPE 153

This Plug & Play Cable is compatible with the automotive sensors DRVEGRD 169 and UMRR-96 Type 153.

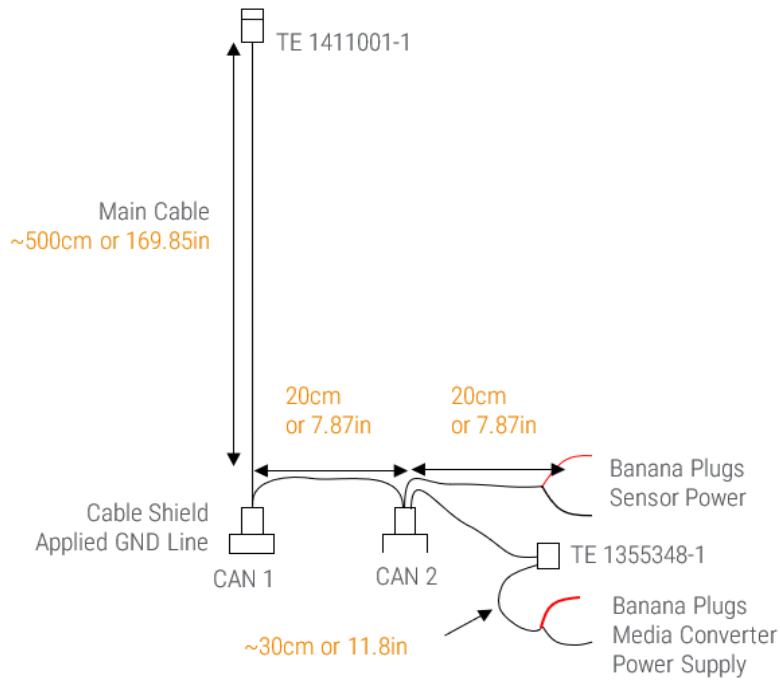
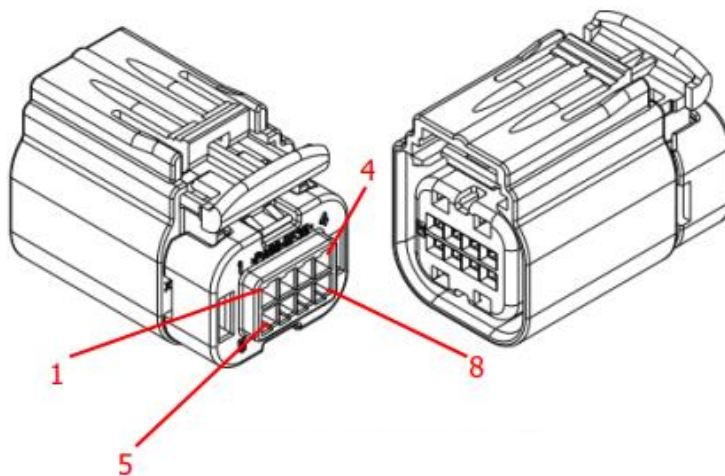

Figure 5 - Illustration of the cable length and connectors

Parameter	Details
Length	570cm or 224.4in (for details see Illustration)
Connectors	2x CAN: D-Sub 9 female Body: D-Sub FKH1 from FCT TE Connectivity 1438031-1 (see connector assembly Nr.1 below) TE Connectivity 1355348-1 (see connector assembly Nr.2 below)
Main Cable	4-pair twisted pair, copper strands, common shield, diameter insulation: 1,4 - 2,06mm
CAN 1 to CAN 2	6-line non-twisted or twisted pair
CAN 2 to Banana Plugs Sensor Power & CAN 2 to TE 1355348-1	2-line
TE 1355348-1 to Banana Plugs Media Converter Power Supply	2x 1-line



*Figure 6 – Plug & Play Cable for DRVEGRD 169 and UMRR-96 TYPE 153*



*Figure 7 - Sensor connector TE Connectivity 1411001-1*

TE 1411001-1		Pair	Label	CAN 1	CAN 2	Banana Plug Sensor Power	TE 1355348-1	Banana Plug Automotive Ethernet Power
1	1		GND	3	3	Black	10	Black
2	2		BroadR_P				9	
3	3		CAN2_H		7			
4	3		CAN2_L		2			
5	1		V+ (Sensor)			Red		
6	2		BroadR_N				8	
7	4		CAN1_H	7				
8	4		CAN1_L	2				
SHIELD	-		SHIELD	3				
			V+ (Autom. Ethernet)				1	Red

Shield and all grounds connected on/before Pin 3 CAN 1.

### 2.1.3 PLUG & PLAY CABLE FOR UMRR-11 TYPE 132 AUTOMOTIVE

The Plug & Play Cable for UMRR-11 (previously referred to as CABLE-0C0200) is compatible with the smartmicro sensor UMRR-11 Type 132 Automotive.

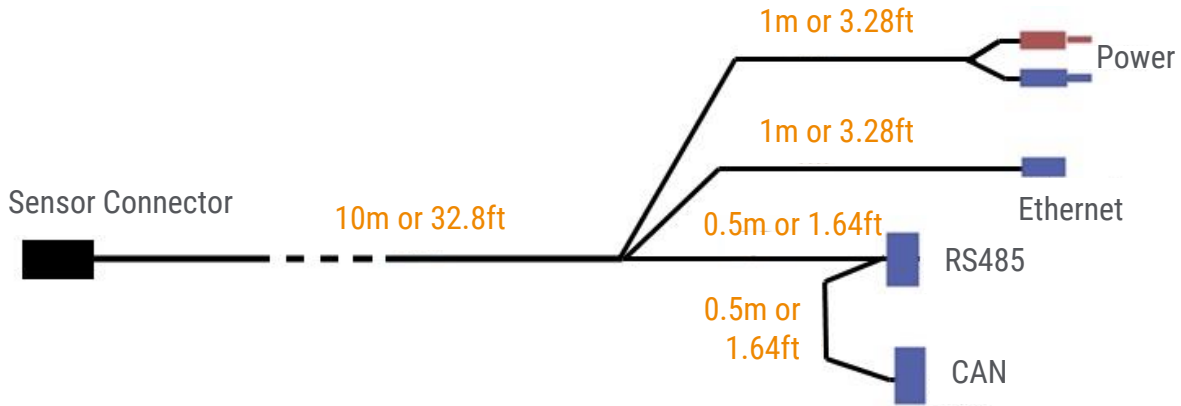

Figure 8 - Illustration of the cable length and connectors

#### TECHNICAL DATA

Parameter	Typical Values
Length	13m or 42.65ft (for details see illustration)
Connectors	Sensor Connector: HIROSE LF10WBP-12S
	RS485: D-Sub 9 female
	CAN: D-Sub 9 female
	Ethernet
	Power
Cable Type	Main: KU110C12J001, SCRN, 6PAIR
	Power: H03VVH2-F; 2-pin; oval; gray; 1.0m
	Network: Network Cable (LAN, RS485, CAN)



*Figure 9 – Plug & Play cable for UMRR-11, including connectors*

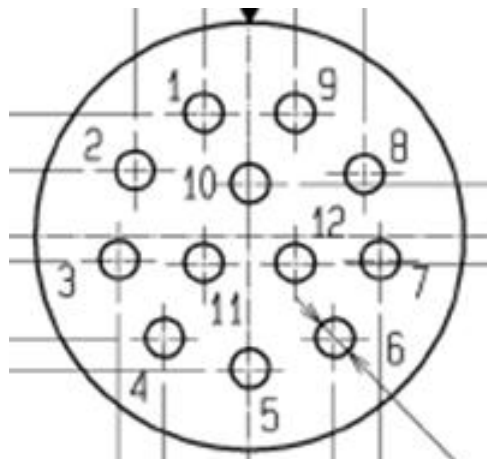

*Figure 10 - Sensor connector HRS LF10WBP-12S (rear view)*

**LAYOUT**

Pins	Color		Label	DSUB-9-f CAN	DSUB-9-f RS485	Ethernet	Banana Power
1	grey/red	◆	Copro_Tx1_P			1	
2	red/blue	◆	Copro_Tx1_N			2	
3	pink	◆	Sensor RS485 RX L		1		
4	gray	◆	Sensor RS485 RX H		2		
5	brown	◆	Sensor RS485 TX L		4		
6	white	◇	Sensor RS485 TX H		3		
7	blue	◆	GND	3			black (blue)
8	red	◆	V-Supply				red (brown)
9	black	◆	Copro_Tx2_N			6	
10	violet	◆	Copro_Tx2_P			3	
11	green	◆	CAN_H	7	120 Ω		
12	yellow	◆	CAN_L	2	120 Ω		
	SHIELD						

## 2.2 CABLE STUMPS

The cable stumps allow for flexibly connecting a smartmicro sensor.

The following types are available:

Cable Type	Sensor Compatibility	Connecting To
Cable stump for DRVEGRD 171 and DRVEGRD 152 <sup>4</sup>	DRVEGRD 171 DRVEGRD 152	Sensor Connector
Cable stump for DRVEGRD 169 and UMRR-96 Type 153 <sup>5</sup>	DRVEGRD 169 UMRR-96 Type 153	Sensor Connector
Cable stump for UMRR-11 Type 132 Automotive <sup>6</sup>	UMRR-11 Type 132 Automotive	Sensor Connector

<sup>4</sup> Previously referred to as CABLE-FF0039

<sup>5</sup> Previously referred to as CABLE-FF0031

<sup>6</sup> Previously referred to as CABLE-0C0301

### 2.2.1 CABLE STUMP FOR DRVEGRD 171 AND DRVEGRD 152

The cable stump for DRVEGRD 171 and DRVEGRD 152 (previously referred to as CABLE-FF0039) is compatible with the smartmicro automotive sensors DRVEGRD 171 and DRVEGRD 152. Instead of ready-to-use connectors, this cable has on one side the required sensor connector, and on the other side open wires.

#### CABLE LENGTH

Total length	approx. 10m (9.70in)
Open end	Peeled exterior insulation approx. 10.0cm (3.93in)
Strands	Stripped and tinned approx. 3.0mm (0.11in)

#### TECHNICAL DATA

Cable type	4-pair Twisted Pair, copper strands, Common shield
Supplier	not defined, example Product: Farnell 1491457
Wire Area	0.50mm <sup>2</sup> - 0.75mm <sup>2</sup>
Diameter insulation	1.4mm – 2.06mm

#### LAYOUT

Molex 031404-9110	Pair	Color		Label
Pin 1	1	Green	◆	V+ (Sensor)
Pin 2	1	White	◇	GND
Pin 3	2	Yellow	◆	BroadR_N
Pin 4	2	Brown	◆	BroadR_P
Pin 5	3	Pink	◆	CAN2_L
Pin 6	3	Gray	◆	CAN2_H
Pin 7	4	Red	◆	CAN1_L
Pin 8	4	Blue	◆	CAN1_H
SHIELD	-	-		SHIELD

### 2.2.2 CABLE STUMP FOR DRVEGRD 169 AND UMRR-96 TYPE 153

The cable stump for DRVEGRD 169 and UMRR-96 Type 153 (previously referred to as CABLE-FF0031) is compatible with the smartmicro automotive sensors DRVEGRD 169 and UMRR-96 Type 153. This cable has the required sensor connector on one side, and open wires on the other side.

#### CABLE LENGTH

Total length	Approx. 5m (4.85in)
Open end	Peeled exterior insulation approx. 5cm (1.96in)
Strands	Stripped and tinned approx. 5cm (1.96in)

#### TECHNICAL DATA

Cable type	4-pair Twisted Pair, copper strands, Common shield
Supplier	Not defined, example product: Farnell 1491457
Wire Area	0.50mm <sup>2</sup> - 0.75mm <sup>2</sup>
Diameter insulation	1.4mm – 2.06mm

#### LAYOUT

TE 1411001-1	Pair	Color		Label
Pin 1	1	White	◇	GND
Pin 2	2	Brown	◆	BroadR_P
Pin 3	3	Green	◆	CAN2_H
Pin 4	3	Yellow	◆	CAN2_L
Pin 5	1	Red	◆	V+ (Sensor)
Pin 6	2	Pink	◆	BroadR_N
Pin 7	4	Blue	◆	CAN1_H
Pin 8	4	Gray	◆	CAN1_L
SHIELD	-	-		SHIELD

### 2.2.3 CABLE STUMP CABLE FOR UMRR-11 TYPE 132 AUTOMOTIVE

The Cable stump for UMRR-11 Type 132 Automotive (previously referred to as CABLE-0C0301) is compatible with the smartmicro automotive sensor UMRR-11 Type 132 Automotive. This cable has the required sensor connector on one side, and open wires on the other side.

#### CABLE LENGTH

Total length	Approx. 5m (4.85in)
Open end	Peeled exterior insulation approx. 10cm (3.93in)
Strands	Stripped and tinned approx. 3.0mm (0.11in)

#### TECHNICAL DATA

Cable type	Highly flexible PVC-Control Line, shielded, twisted pair, UV-resistant Type UL/cUL-LIH 5x(2xAWG26 ST)+1x2xAWG24 C11Y, 12 pole, black
Supplier	Not defined, example product: MEDI Kabel KU110C12J002
Outer diameter	6.50 ±0.25mm (roughly 0.255in)

#### LAYOUT

HRS LF10WBP-12S	Pair	Color		Label
Pin 1	1	Grey/Red	◆	Eth_Tx1_P
Pin 2		Red/Blue	◆	Eth_Tx1_N
Pin 3	2	Pink	◆	Sensor RS485 RX L
Pin 4		Gray	◆	Sensor RS485 RX H
Pin 5	3	Brown	◆	Sensor RS485 TX L
Pin 6		White	◇	Sensor RS485 TX H
Pin 7	4	Blue	◆	GND
Pin 8		Red	◆	V+ (Sensor)
Pin 9	5	Black	◆	Eth_Tx2_N
Pin 10		Violet	◆	Eth_Tx2_P
Pin 11	6	Green	◆	CAN_H
Pin 12		Yellow	◆	CAN_L
SHIELD	-	-		SHIELD

### 3 LEGAL DISCLAIMER NOTICE

All products, product specifications and data in this document may be subject to change without notice to improve reliability, function or otherwise.

Not all products and/or product features may be available in all countries and regions. For legal reasons features may be deleted from products or smartmicro may refuse to offer products. Statements, technical information and recommendations contained herein are believed to be accurate as of the stated date. smartmicro disclaims any and all liability for any errors, inaccuracies or incompleteness contained in this document or in any other disclosure relating to the product.

To the extent permitted by applicable law, smartmicro disclaims (i) any and all liability arising out of the application or use of the product or the data contained herein, (ii) any and all liability of damages exceeding direct damages, including - without limitation - indirect, consequential or incidental damages, and (iii) any and all implied warranties, including warranties of the suitability of the product for particular purposes.

Statements regarding the suitability of products for certain types of applications are based on smartmicro's knowledge of typical requirements that are often placed on smartmicro products in generic/general applications. Statements about the suitability of products for a particular/specific application, however, are not binding. It is the customer's/user's responsibility to validate that the product with the specifications described is suitable for use in the particular/specific application. Parameters and the performance of products may deviate from statements made herein due to particular/specific applications and/or surroundings. Therefore, it is important that the customer/user has thoroughly tested the products and has understood the performance and limitations of the products before installing them for final applications or before their commercialization. Although products are well optimized to be used for the intended applications stated, it must also be understood by the customer/user that the detection probability may not be 100% and that the false alarm rate may not be zero.

The information provided, relates only to the specifically designated product and may not be applicable when the product is used in combination with other materials or in any process not defined herein. All operating parameters, including typical parameters, must be validated for each application by the customer's/user's technical experts. Customers using or selling smartmicro products for use in an application which is not expressly indicated do so at their own risk.

This document does not expand or otherwise modify smartmicro's terms and conditions of purchase, including but not being limited to the warranty. Except as expressly indicated in writing by smartmicro, the products are not designed for use in medical, life-saving or life-sustaining applications or for any other application in which the failure of the product could result in personal injury or death.

No license, expressed or implied, by estoppel or otherwise, to any intellectual property rights is granted by this document or by any conduct of smartmicro. Product names and markings noted herein may be trademarks of their respective owners.

Please note that the application of the product may be subject to standards or other regulations that may vary from country to country. smartmicro does not guarantee that the use of products in the applications described herein will comply with such regulations in any country. It is the customer's/user's responsibility to ensure that the use and incorporation of products comply with regulatory requirements of their markets.

If any provision of this disclaimer is, or is found to be, void or unenforceable under applicable law, it will not affect the validity or enforceability of the other provisions of this disclaimer.